

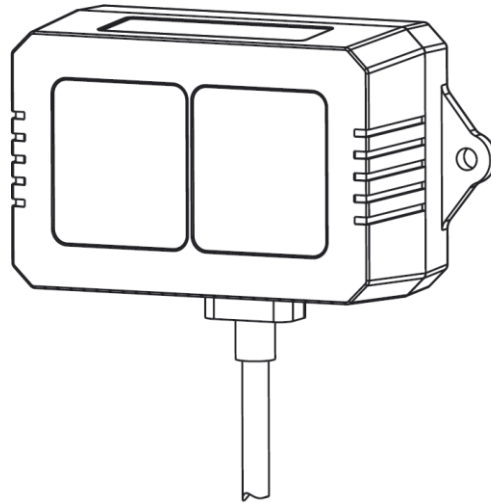

TF02-Pro User Manual



PREFACE

Dear users:

Thank you for choosing Benewake products. In the purpose of offering better operation experience to you, we hereby write this manual for an easier and simpler operation of our product, hoping to better solve the common problems you may meet.

This user manual contains the relevant information on product introduction, usage and maintenance of TF02-Pro, covers the product operation introduction and common problem solutions. Please read this manual carefully before using the product. Remember the precautions to avoid hazards, and please follow the described steps in the manual when using it.

If you have any problems in the process of usage, you are welcome to contact Benewake at any time for help.

Contact details

Official website: en.benewake.com

TEL : +86-10- 57456983

Technical questions, please contact : support@benewake.com

Consult sale information or request brochure, please contact : bw@benewake.com

Headquarter Address

Benewake (Beijing) Co., Ltd.

No.3030, 3rd Floor, Independent Innovation Building, No.6 Chuangye Road, Haidian District, Beijing, China

Copyright Statement

This User Manual is copyright © of Benewake. Please do not modify, delete or translate the description of this manual contents without the official written permission from Benewake.

Disclaimer

As our products are constantly improving and updating, the specifications of TF02-Pro are subject to change. Please refer to the official website for latest version.

CONTENTS

1	OVERVIEW.....	1
1.1	Technical Specification.....	1
1.2	Maintenance and Cleaning.....	2
1.3	Appearance and Structure	2
1.4	Storage	3
1.5	Application	4
2	INTERFACE.....	5
2.1	Description About Wiring Sequence.....	5
2.2	Electrical Characteristics.....	5
3	COMMUNICATION PROTOCOL	6
3.1	Serial Communication Protocol.....	6
3.2	Serial Communication Data Format.....	6
3.2.1	Standard data output format	6
3.2.2	Character string data format.....	7
3.3	I ² C Communication Protocol.....	7
3.4	Timing Sequence Description of I ² C	7
3.5	I/O Communication Mode.....	7
4	PARAMETER CONFIGURATION.....	9
4.1	Command Convention.....	9
4.2	Configuration Commands.....	9
5	QUICK TEST GUIDE	12
5.1	Tools Required for Test.....	12
5.2	Test Procedures.....	12
6	Firmware Update	14
7	Q&A	16
	Attachment-1 BW_TFDS software.....	19

1 OVERVIEW

TF02-Pro is a medium-range LiDAR, ranging performance up to 40m, based on the principle of ToF (time of flight), it can be widely used in drone altitude hold and measurement, intelligent transportation, managing parking lots, smart agriculture and other fields. TF02-pro is the upgraded version, and it has optimized optical system and algorithm to achieve better realization in outdoor in the presence of ambient light, different reflectivity backgrounds and temperature.

1.1 Technical Specification

Table 1-1 Technical Specification of TF02-Pro

Type	Parameters	Values	
Product performance	Operating range	90% reflectivity, 0Klux	0.1m~40m
		10% reflectivity, 0Klux	0.1m~13.5m
		90% reflectivity, 100Klux	0.1m~40m
		10% reflectivity, 100Klux	0.1m~13.5m
	Accuracy ^①	±5cm (0.1m~5m), ±1% (5m~40m)	
	Distance resolution ^①	1cm	
	Frame rate ^②	1Hz~1000Hz (adjustable, default 100Hz)	
	Repeatability ^①	1σ: <2cm (0.1m~35m@90% reflectivity)	
	Ambient light immunity	100Klux	
	Enclosure rating	IP65	
Optical parameters	Photobiological safety	Class1 (IEC60825)	
	Central wavelength	850nm	
	Light source	VCSEL	
	FoV ^③	3°	
Electrical parameters	Supply voltage	DC 5V~12V	
	Average current	≤200mA	
	Power consumption	≤1W	
	Peak current	300mA	
	Communication level	LVTTL (3.3V)	
	Communication interface	UART, I ² C, I/O	
Others	Dimension	69mm×41.5mm×26mm (L×H×W)	

	Housing	PC/ABS
	Operating temperature	-20°C~60°C
	Storage temperature	-30°C~80°C
	Weight	50g (with cables)
	Cable length	80cm



Note

- ① The detection range is determined with the standard white board (90% reflectivity).
- ② The frame rate can be adjusted. The default value is 100Hz and the maximum value is 1000Hz, the customized frame rate should be calculated by the formula: $2000/n$ (n is an integer with ≥ 2).
- ③ The angle is a theoretical value, the actual angle value has some deviation.

1.2 Maintenance and Cleaning

- Before switching on, please check if the exposed window is clean, if it is dirty clean it promptly.
- After using the device, check the optics. If it is contaminated, please clean it promptly.
- The optics should be cleaned regularly if the device be operated in a severe environment for a long time.
- Before regular cleaning, please disconnect the power. Using a soft cloth to gently wipe the window in the same direction when the device is not operating, to avoid repeated wiping and damage to the LiDAR window.
- When cleaning the window, do not use alcohol to clean, so as not to damage the window.
- If you require deep cleaning of internal optics, please contact bw@benewake.com to offer professional advice.

1.3 Appearance and Structure

The appearance and dimensions of TF02-Pro are shown in Figure 1-1 and Figure 1-2:



Figure 1-1 Appearance of TF02-Pro

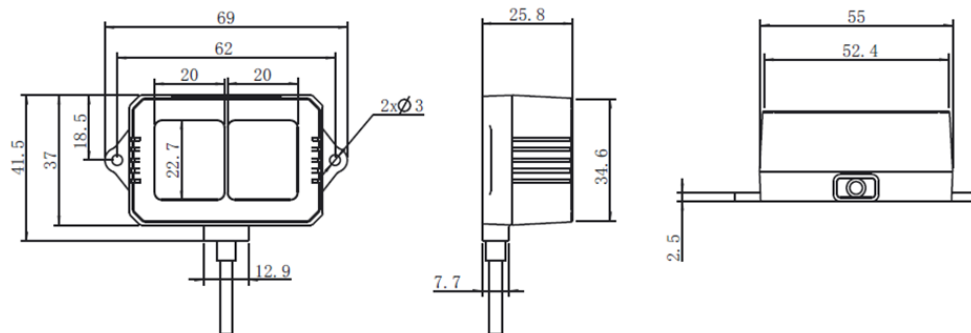

Figure 1-2 Dimensions of TF02-Pro (Unit: mm)

TF02-Pro is recommended to use M2.5 round Phillips screws for installation. Please remove the protective film of the optical lens before use. The lens of front panel of LiDAR cannot be covered. Please keep it clean. The surface of optical lens is the ranging zero of LiDAR.

The detection angle of TF02-Pro is 3°. At different distances, the size of light spot, namely the edge length of the detection range, is different. Side length of the detection range at different distances (the detection range is a square), is shown in Table 1-2.

Table 1-2 Spot Size at Different Distances

Distance (m)	1	2	3	5	7	10	20	30	40
Spot Size (cm)	5	10	16	26	37	52	105	156	208



Note

The side length of target object generally should be larger than size of the TF02-Pro light spot; if the side length of the detected object is smaller than size of light spot, the output (Distance) from TF02-Pro will be a value between the actual distance values of the two objects.

1.4 Storage

- Device should be stored at -30°C to 80°C with a relative humidity ≤ 60% and

ventilation free from corrosive gases.

- Before storage, please make sure that all connections are disconnected or dust covers are inserted or covered to ensure cleanliness.
- If storage time is over three months, please carry out a working test before using, to ensure that the device can be used in normal condition.
- For ensuring the product performance, do not open the product shell or remove the IR-pass filter.

1.5 Application

When using the product, please read the specifications, user manual and the precautions mentioned in the user manual in detail to ensure that the product is used within the rated specifications. The product is designed for use in the following scenarios:

- Intelligent transportation
- Smart parking lot
- Material level detection
- Drone
- Other consumer products

If you use the product beyond the above application scope, please carefully evaluate whether the reliability requirements of the product to be applied match this product, or contact Benewake at any time to provide suggestions and useful hints to avoid any unpleasant situations.

2 INTERFACE

2.1 Description About Wiring Sequence

TF02-Pro has an 80cm long connecting wire with a 1.25-4P connector, which shown in Figure 2-1.

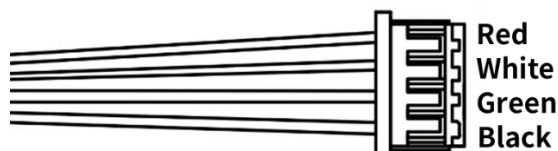

Figure 2-1 TF02-Pro external wiring connector and wiring sequence

The wiring sequence is shown in Table 2-1.

Table 2-1 The Function Description of Each Wire

Wiring Color	Function	Comment
Red	VCC	Power supply
White	RXD/SDA	Receiving/Data
Green	TXD/SCL	Transmitting/Clock
Black	GND	Ground

2.2 Electrical Characteristics

TF02-Pro has no overvoltage nor polarity protection, so please make sure that connection and power supply is normal.

Table 2-2 Main Electrical Parameters of TF02-Pro

Parameters	Value
Supply voltage	DC 5V~12V
Average current	$\leq 200\text{mA}$
Peak current	300mA
Average power consumption	$\leq 1\text{W}$
Communication level	LVTTL (3.3V)

3 COMMUNICATION PROTOCOL

3.1 Serial Communication Protocol

TF02-Pro adopts the serial data communication protocol, as given in Table 3-1.

Table 3-1 Data Communication Protocol of TF02-Pro: UART

Communication interface	UART
Default baud rate	115200
Data bit	8
Stop bit	1
Parity check	None

3.2 Serial Communication Data Format

TF02-Pro is available with two formats of data output, namely the standard data output format and the character string data format, both of which are switchable with command.

3.2.1 Standard data output format

The serial data format of TF02-Pro is shown in Table 3-2, the data is hexadecimal, each data frame contains 9 bytes, including the distance value, signal strength, temperature of chip and data check byte (Checksum).

Table 3-2 Data Format and Code Explanation

Byte0-1	Byte2	Byte3	Byte4	Byte5	Byte6	Byte7	Byte8
0x59 59	Dist_L	Dist_H	Strength_L	Strength_H	Temp_L	Temp_H	Checksum
Data code explanation							
Byte0	0x59, frame header, same for each frame						
Byte1	0x59, frame header, same for each frame						
Byte2	Dist_L distance value low 8 bits						
Byte3	Dist_H distance value high 8 bits						
Byte4	Strength_L low 8 bits						
Byte5	Strength_H high 8 bits						
Byte6	Temp low 8 bits						
Byte7	Temp high 8 bits						
Byte8	Checksum is the lower 8 bits of the cumulative sum of number of first 8 bytes						

- Dist (Distance): The detection distance value with TF02-Pro, default unit is cm.
- Strength: The signal strength, the default output is between 0 and 65535. When the distance measuring gear is certain, the farther the distance is measured, the lower the signal intensity; the lower the reflectivity of the target, the lower the signal intensity
- Temp(Temperature): The chip temperature, temperature(°C) = Temp / 8 -256.

3.2.2 Character string data format

The data output is in the format of character string and its unit is m(meter). For example, if the measurement distance is 1.21m, the string 1.21 will be output, followed by the escape character `\r\n`.

3.3 I²C Communication Protocol

TF02-Pro supports I²C data communication interface, as shown in the table below:

Table 3-3 Data Communication Protocol of TF02-Pro: I²C

Communication interface	I ² C
Max transmission rate	400kbps
Master/Slave mode	Slave mode
Default Address	0x10
Address range	0x01~0x7F

3.4 Timing Sequence Description of I²C

Different from the serial mode, the I²C communication is initiated by the master. TF02-Pro can only send and receive data passively, as slave. After sending the command from master to slave, one needs to wait for a period for the command to be processed, then read response of LiDAR. The suggested waiting period is 100ms. Data is detailed in Table 3-4.

Table 3-4 Timing Sequence of I²C

Write operation	Start	Addr	W	A	Byte0	A	---	ByteN	A	Stop
Wait 100ms										
Read operation	Start	Addr	R	A	Byte0	A	---	ByteN	A	Stop

3.5 I/O Communication Mode

I/O output mode is supported and could be enabled by related command. Through the communication level change of pin 3 (green wire), whether there is an object in the

detection range, the working mode of I/O mode is shown in Figure 3-1. TF02-Pro supports three I/O modes, the default is mode0, which means turning off the I/O mode. Mode parameters are as follows:

- Mode0: data output mode.
- Mode1: I/O mode, near high and far low.
- Mode2: I/O mode, near low and far high.

Dist: critical value, near end value in hysteresis zone, unit is cm, default number is 0.

Zone: hysteresis zone range, unit is cm; default value is 0 (there is no hysteresis zone).

The hysteresis zone could be set by the command, when output is near zone level, output will be switched to far zone level if measured result is higher than far end point; when output is far zone level, output is switched to near zone level if measured result is lower than near end point. (High level: 3.3V, low level: 0V)

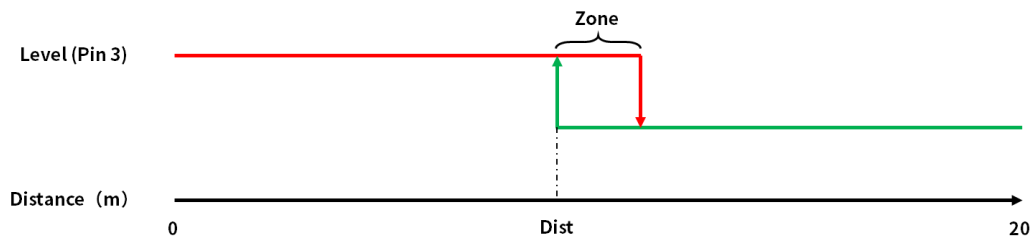

Figure 3-1 The description of I/O mode

4 PARAMETER CONFIGURATION

In order to allow TF02-Pro to solve your problems more flexibly, the function of user-defined configuration of product parameters is opened. Users can modify the original parameters of the product by sending relevant instructions, such as output data format, frame rate, etc.

Please modify product configuration depending upon your actual demands. Do not frequently try irrelevant commands to prevent incorrect sending of command which may cause unnecessary loss. Please make sure to use the commands listed herein. Do not send unstated commands.

4.1 Command Convention

For the configuration instructions in this document, see the following command convention:

- Multi-bytes data or command frame is transmitted in little endian format. For example: set the frame rate to 1000Hz, as shown in Table 4-1. Decimal number 1000 can be converted to 0x03E8 in hexadecimal. Then it will be saved in the data or command frame as:

0x5A 0x06 0x03 0xE8 0x03 0x4E

- Command: data instruction frame sent from PC to LiDAR.
- Response: data frame sent by LiDAR to host computer or other terminals.

Before setting the relevant parameters of TF02-Pro, user needs to establish the connection between TF02-Pro and PC at first. User can send the relevant configuration-related instructions to the product via TF02-Pro PC software or other serial port debugging software. All commands are compatible with both UART mode and I²C mode.

4.2 Configuration Commands

The general parameters configuration command is shown in Table 4-1. After parameters configuration, send saving settings command to save the configuration, otherwise the settings will not take effect.

Table 4-1 General Parameter Configuration and Description for TF02-Pro

Parameters	Command	Response	Remark
Firmware version	5A 04 01 5F	5A 07 01 V1 V2 V3 SU ^①	Version V3.V2.V1

System reset ²	5A 04 02 60	5A 05 02 00 61	Succeeded
		5A 05 02 01 62	Failed
Frame rate ³	5A 06 03 LL HH SU	5A 06 03 LL HH SU	1-1000Hz, default 100Hz
Trigger detection	5A 04 04 62	Date frame	After setting the frame rate to 0, detection can be triggered with this command
Output format	5A 05 05 01 65	5A 05 05 01 65	Standard 9 bytes(cm)
	5A 05 05 02 66	5A 05 05 02 66	Character string(m)
	5A 05 05 06 6A	5A 05 05 06 6A	Standard 9 bytes (mm)
Baud rate ⁴	5A 08 06 H1 H2 H3 H4 SU	5A 08 06 H1 H2 H3 H4 SU	Default 115200; E.g. 256000(DEC)=3E800(HEX) , H1=00,H2=E8,H3=03,H4=00
Enable/Disable output	5A 05 07 00 66	5A 05 07 00 66	Disable data output
	5A 05 07 01 67	5A 05 07 01 67	Enable data output
Communication interface setup	5A 05 0A MODE SU	/	00 (UART), default; 01 (I ² C)
Modify I ² C_slave_addr	5A 05 0B ADDR SU	5A 05 0B ADDR SU	Modify I ² C_slave_addr, default 0x10
Obtain data frame	5A 05 00 01 60	Data Frame (9bytes-cm)	Only works in I ² C mode
	5A 05 00 06 65	Data Frame (9bytes-mm)	
I/O mode enable	5A 09 3B MODE DL DH ZoneL ZoneH 00	/	Enable/disable I/O output mode; MODE (default 0): 0--standard data mode; 1--I/O, near high and far low; 2--I/O, near low and far high; Zone: hysteresis zone
Strength threshold and distance under threshold	5A 07 22 XX LL HH SU	5A 07 22 XX LL HH SU	Strength Threshold=60, Distance under threshold=4500. E.g. When strength is below 60, make distance output 4500cm. XX=60/10=6(DEC)=06(HEX) 4500(DEC)=1194(HEX) LL=94, HH=11
Low power consumption mode	5A 06 35 0X 00 SU	5A 06 35 0X 00 SU	Range of X(HEX) is 0~A: X > 0, enable low power consumption mode; X=0, disable low power

			consumption mode, default
Restore to factory settings	5A 04 10 6E	5A 05 10 00 6F	Succeeded
		5A 05 10 01 70	Failed
Save settings ^⑤	5A 04 11 6F	5A 05 11 00 70	Succeeded
		5A 05 11 01 71	Failed







Warning

- ① SU is checksum, checksum is disabled by default.
- ② Please keep power on and wait 1s after sending system reset command, otherwise the settings will not take effect.
- ③ The customized frame rate should be calculated by the formula: $2000/n$ (n is an integer with ≥ 2).
- ④ The following baud rates are supported: 9600, 14400, 19200, 38400, 56000, 57600, 115200, 128000, 230400, 256000, 460800, 512000, 750000, 921600. When setting a high frame rate, high baud rate is recommended to ensure data security. After sending baud rate command, keep power on and switch to the target baud rate before sending save setting command, it will be effective in this way.
- ⑤ After parameters configuration, send saving settings command to save the configuration, otherwise the settings will not take effect.

5 QUICK TEST GUIDE

5.1 Tools Required for Test

				
TF02-Pro	TTL-USB converter	USB cable	PC	BW_TFDS Software

5.2 Test Procedures

- 1) Download the test software

Download the latest version BW_TFDS from <http://en.benewake.com/support>.

The introduction of BW_TFDS software is shown in Attachment-1 BW_TFDS software.

- 2) Connection of the hardware

Connect “TF02-Pro”, “TTL-USB board” and “USB cable”. Make sure there is no loose connection. Then connect “USB cable” with “PC”. As shown in Figure 5-1.



Figure 5-1 Connection of TF02-Pro and PC

- 3) Connection to the software

Run BW_TFDS software, select “① TF02-Pro” and select automatically recognized communication port (here it is “② COM9”), choose the right baud rate (here it is “③ 115200”), as shown in Figure 5-2.

- 4) Data output

Then click “CONNECT”. Upon successful connection, the continuous graph of the output data will be displayed in area “④ TIME LINE CHART”. Besides, the real-time data of the current measured distance (Dist), effective data points per second (Effective Points) and signal strength (Strength) will be displayed in area “⑤ REAL TIME DATA”.

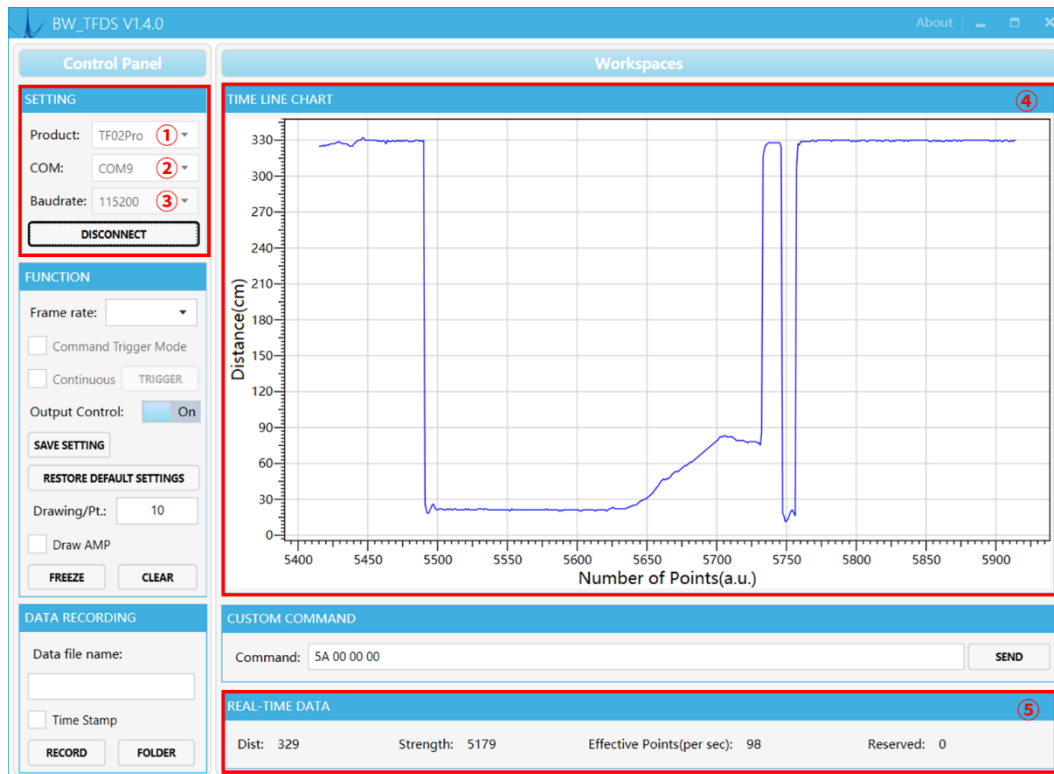

Figure 5-2 BW_TFDS software interface and display



Note

- ① Please turn off any anti-virus software before uncompressing the PC software. Otherwise, the software maybe detected as virus and deleted by anti-virus. The software is only runnable under Windows.
- ② If no data is available in area “④TIME LINE CHART”, please check the wire connection and sequence. When TF02-Pro is successfully powered on, there will be a red indicator light inside transmitting lens viewing from the front.
- ③ The value of distance output Dist may vary with the output unit, which is cm by default. If the unit of distance is changed to the unit-mm with specific command, and the PC software will be unable to identify it, and so the unit of “④TIME LINE CHART” will still be cm. For example, the actual TF02-Pro measurement is 1m, the distance value of TF02-Pro is 1000 in mm, the value read by the PC software also is 1000, but the unit will not change and still display cm.

6 Firmware Update

TF02-Pro supports the firmware upgrade. When the user’s product cannot satisfy the current application requirements and Benewake official website has relevant firmware upgrades, the user may upgrade the product firmware via Updater_BENEWAKE software. Please contact us to get the updater if you cannot find it on our official website.

The tools for the firmware upgrade of TF02-Pro are mostly the same as QUICK TEST GUIDE, which requires one TTL-USB board to connect the TF02-Pro with PC. The upgrade process is as follows:

- 1) Run Updater_BENEWAKE.exe, Select right port, here is “①COM9” . Input the right baud rate in “② 115200” and click “③ CONNECT” to connect the TF02-Pro with the software. As shown in Figure 6-1.

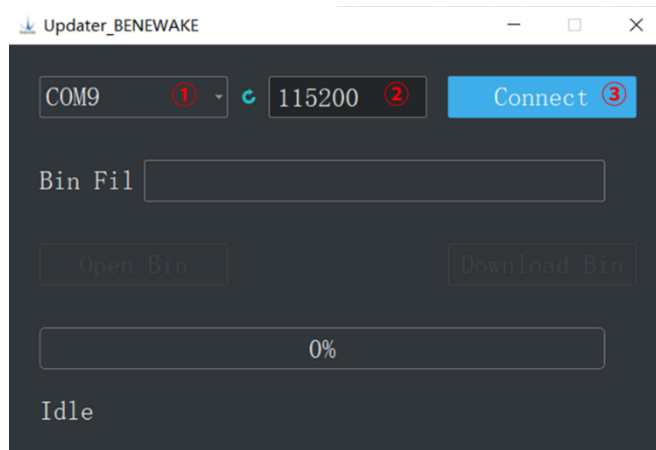

Figure 6-1 Connect the TF02-Pro with the software

- 2) Click “④ Open Bin” to choose the firmware being flashed, the message “⑥Read bin done” will be displayed after the file is uploaded. Then click “⑤ Download Bin” to start upgrading. As shown in Figure 6-2.

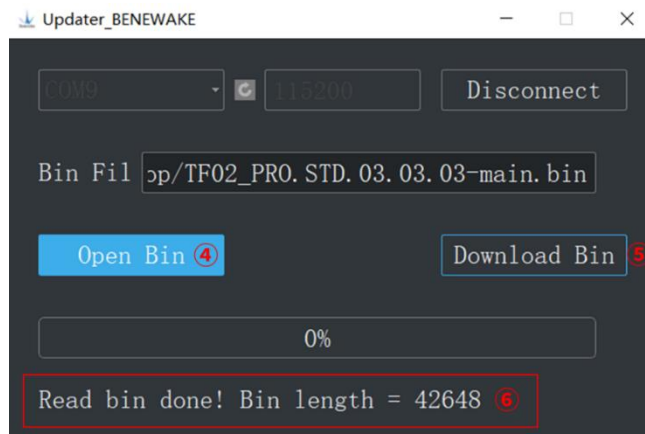

Figure 6-2 Upload firmware file

- 3) Check the status of the progress bar, 100% indicates that the upgrade is complete, and

appear "⑦Jump done".

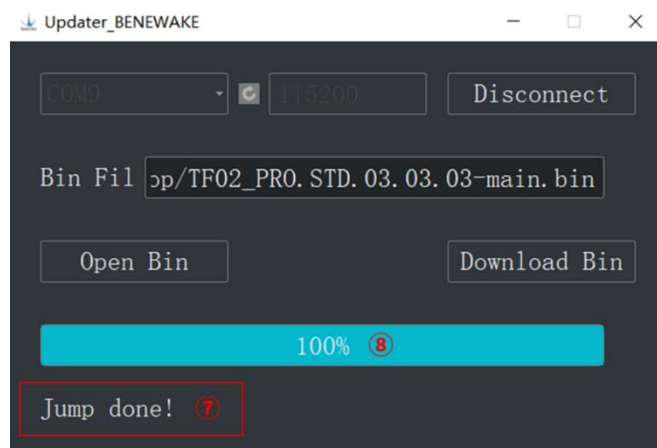

Figure 6-3 Upgrade is complete

7 Q&A

1) Distance value occasionally will abruptly change into 4500 beyond the range during normal operation.

Cause:

Different test environments (reflectivity of detected object, disturbance of ambient light, etc.) will affect the signal strength of TF02-Pro. For a reliable and stable measurement data, the algorithm elimination is internally used for TF02-Pro. In case of the insufficient signal strength, TF02-Pro will output 4500. This value is not measurement data of TF02-Pro, which is only used to remind the user that such data is unreliable.

Troubleshooting:

Please use such value as the trigger signal of some unreliable data, and it will ensure that your system can use other reliable data for further assessment and decision-making if there are some unreliable data.

2) Significant error between the output distance value of LiDAR and actual distance.

Cause①:

Incorrect interpretation of the data communication protocol of TF02-Pro.

Troubleshooting:

Check data communication interpretation means. In case of such error, please check the data format to adjust interpretation means.

Cause ②:

Due to the detection principle of TF02-Pro, the above phenomenon is likely to occur if the detection object is the material with high reflectivity (such as mirror, smooth floor tile, etc.) or transparent substance (such as glass and water, etc.)

Troubleshooting:

Please avoid use of this product under such circumstance in practice.

Cause ③:

The IR-pass filters are blocked.

Troubleshooting:

Please use dry dust-free cloth to gently remove the external matter

3) The TF02-Pro outputs an abnormal distance value of 65535.

Cause:

When encountering a measured object with high reflectivity (such as mirror, water, etc.), the received signal will be saturated, at this time, Strength = 65535, and the distance value will become 65534; when the signal strength is insufficient and lower than 60, the distance

value will become the maximum value of 4500.

Troubleshooting:

Please avoid use of this product under such circumstance in practice.

4) No data output.

Cause:

The product will be strictly inspected before leaving our factory, ensuring that all the shipped products can work normally. However, some abnormal working matters maybe still occur because of incidents during the transportation or use.

Troubleshooting:

Check whether the power supply is normal; check whether the voltage is within rated voltage range. If power supply is normal, there will be a red light inside the transmitting lens of TF02-Pro.

Make sure TF02-Pro connection is correct and reliable.

Check whether the data interpretation is correct. Please carry out the interpretation as per the data format specified herein.

If the fault persists, please contact technical support.

5) There is no data output when Benewake LiDAR is connected to the PC software (BW_TFGS software).

Cause①:

The software only supports Microsoft windows operating systems for the time being

Troubleshooting:

Use the PC supporting Microsoft operation system.

Cause②:

TTL-USB board is poorly connected.

Troubleshooting:

Check the TTL -USB board with the correct and reliable connection with TF02-Pro and PC.

Cause③:

Driver of serial port is not correctly installed.

Troubleshooting:

Plug and unplug USB cable again. Try to reinstall the driver or directly download and install a driver from the internet.

If the PC software still work abnormally, please contact our technical support.

6) The accuracy of TF02-Pro gets worse at 40m against white board and the data fluctuation becomes larger.

Cause:

There are metal objects around the front lens barrel.

Troubleshooting:

Remove or replace metal objects near the lens barrel with non-metallic materials. If the metal material around the lens barrel in your installation position cannot be changed, and there are high requirements for data stability and error at the extreme distance, please contact our technical support.

Attachment-1 BW_TFDS software

BW_TFDS software only supports Windows operating system. It is suitable for any products of TF series, but the output of those products is limited to the serial port communication protocol. Detailed operations are as below.

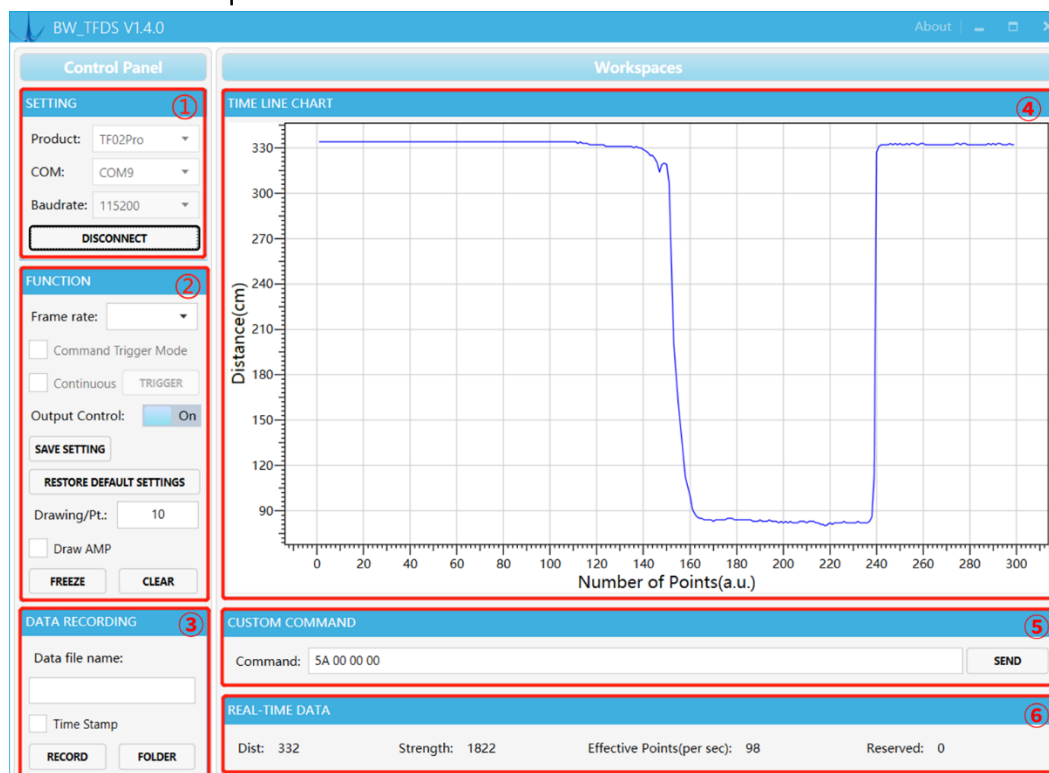

Figure 0-1 BW_TFDS software GUI

1) Product Type/Serial Port Control Zone [SETTINGS]

Product: choose product model, such as TF02-Pro in this case

COM: select the right serial port number corresponding to the LiDAR.

Baud rate: choose the baud rate of LiDAR, which is set to 115200 as default for TF02-Pro.

CONNECT/DISCONNECT: Click [CONNECT] button to establish the connection with LiDAR. Click [DISCONNECT] button to terminate the connection.

2) Function Zone [FUNCTION]

Frame rate: choose frame rate from the drop box, setting will be made immediately, and the change is viewed in [Effective Points].

Output Control: enable/disable the data output of LiDAR, default “On”.

SAVE SETTING: save the frame rate and output settings. click “SAVE SETTING” to save the configuration after setting, otherwise the settings will not take effect.

RESTORE DEFAULT SETTINGS: restore to factory default Settings.

Drawing/Pt: upon receipt of every N frames, the software will draw one point on the chart

[4] the average of the N data. N can be modified depending upon the actual requirement (the value is preferable to be ≥ 10 to prevent the PC software from lagging). After entering the value, press “Enter” key on the keyboard to enable the setting.

Draw AMP: the software will draw the curve of signal strength on the chart [4], take effect immediately after button is selected.

FREEZE/CLEAR: After clicking [FREEZE], time-line chart in zone [4] will stop updating. On clicking [CLEAR], the plotted curve in [4] will be cleared.

3) Data Recording Zone [DATA RECORDING]

Input the name of data file in the textbox. Press [RECORD] button to start recording data and click the [FINISHED] button to stop recording. Click [FOLDER] button to open the folder where the data file is saved.

4) Time Line Chart Zone [TIME LINE CHART]

The PC software will draw the continuous distance measurement curves based on the received data, where y-coordinates represent the current distance data while x-coordinates represent number of points.

5) CUSTOM COMMAND ZONE [CUSTOM COMMAND]

Command: Input the commands in hexadecimal format in the text box and click the [SEND] button above to send the command.

6) Real-time Data Display Zone [REAL-TIME DATA]

Dist: Distance, unit: cm by default.

Strength: the signal strength, values are between 0 and 65535.

Effective Points (per sec): indicates effective points refreshed by TF per second (equals to frame rate).